

ANTARES
INTERNATIONAL

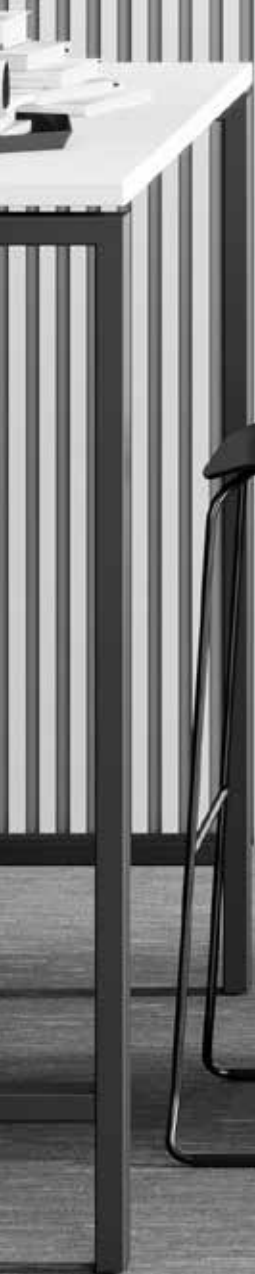

Office furniture
collection 2021

INDEX

OPERATIVE

| | |
|--------|----|
| Pan | 04 |
| Akka | 12 |
| Slim | 22 |
| Ring | 32 |
| Lift | 44 |
| Oasis | 52 |
| Blog | 64 |
| Box | 74 |
| Lounge | 84 |

MANAGERIAL

| | |
|------|-----|
| Slim | 96 |
| Ring | 102 |
| Otto | 108 |
| Glam | 118 |
| Blog | 128 |
| Box | 134 |

PAN_OPERATIVE

Il design essenziale, la solidità costruttiva semplice ma efficace, l'eccellente rapporto qualità prezzo, fanno di Pan un prodotto di successo e di grande interesse per lo sfruttamento razionale dello spazio.

The simple design, the solid easy structure, but effective, the excellent relation between quality and price, make Pan a successful product and very interesting for the rational exploitation of the space.





Gamba intermedia arretrata 550 mm.
Intermediate recessed leg 550 mm.



Pannello frontale in melaminico o tessuto in 2 altezze: 352 / 552 mm dal piano scrivania.

Melamine or fabric frontal screen in 2 heights: 352 / 552 mm from the desktop.



FINITURE / FINISHES

GAMBE E PIANI SCRIVANIA / LEGS AND DESKTOPS

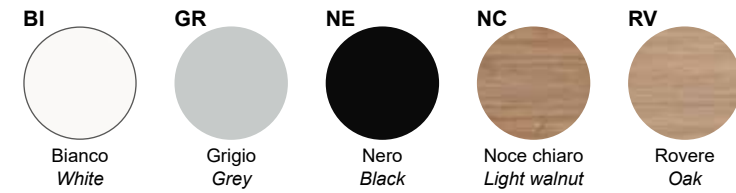

MODESTY PANEL / MODESTY PANEL

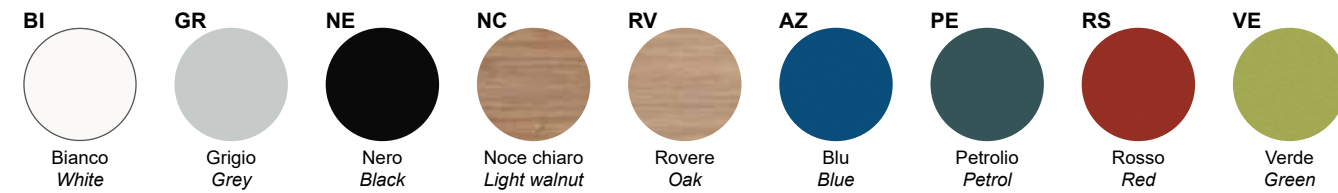

ACCESSORI IN MELAMINICO / MELAMINE ACCESSORIES

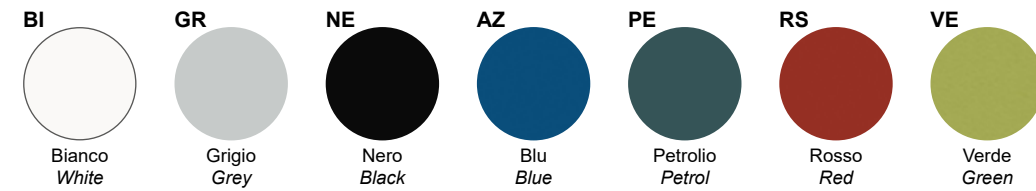

ACCESSORI IN TESSUTO / FABRIC ACCESSORIES

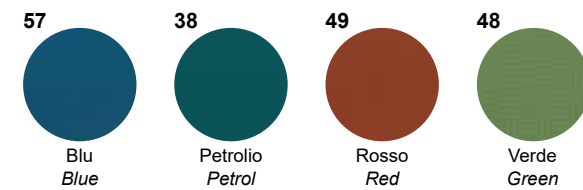

ABACO / ABACUS

SCRIVANIE / DESKS

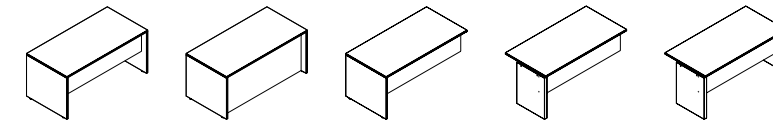

L = 1200 / 1400 / 1600 / 1800 mm
P = 800 mm
H = 740 mm

ALLUNGHI LATERALI / SIDE EXTENSION

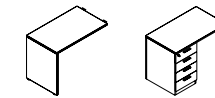

L = 800 / 1000 mm
P = 600 mm
H = 740 mm

ACCESSORI / ACCESSORIES

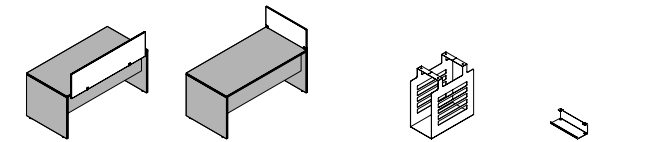

L = 800 / 1060 / 1260 / 1460 / 1660 mm
P = 18 / 28 mm
H = 465 (352) / 665 (552) mm

L = 250 mm
P = 500 mm
H = 560 mm

L = 320 mm
P = 120 mm
H = 100 mm

AKKA_OPERATIVE

Strutture metalliche totalmente canalizzabili costruite per soddisfare i più severi requisiti progettuali. Piani sagomati e rettangolari combinati con varie tipologie di contenitori, rendono possibili composizioni creative e personalizzate.

Metal structures totally cabled made up to fit the most stringent design requirements. Shaped and rectangular tops and the combination of various types of containers, make possible creative compositions and custom workstations.





Porta computer in metallo.
Metal CPU holder.



Scrivania con modesty panel.
Desk with modesty panel.





Struttura metallica totalmente canalizabile.
Metal structure totally cabled.



FINITURE / FINISHES

STRUTTURE IN METALLO / METAL STRUCTURE



PIANI SCRIVANIA / DESKTOPS

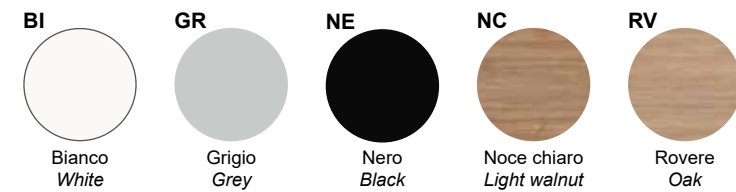

ACCESSORI IN MELAMINICO / MELAMINE ACCESSORIES

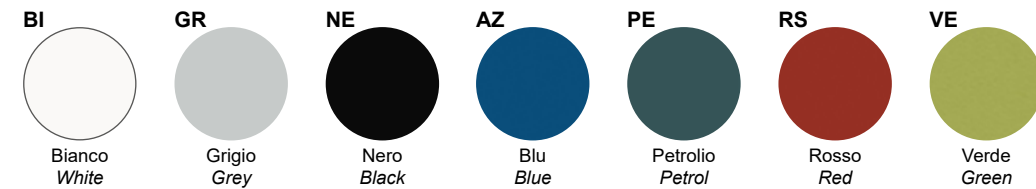

ACCESSORI IN TESSUTO / FABRIC ACCESSORIES

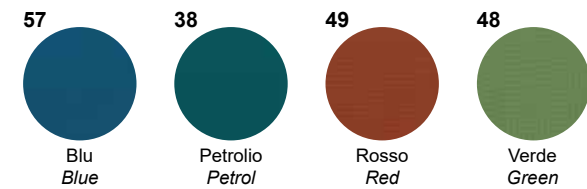

ABACO / ABACUS

SCRIVANIE / DESKS

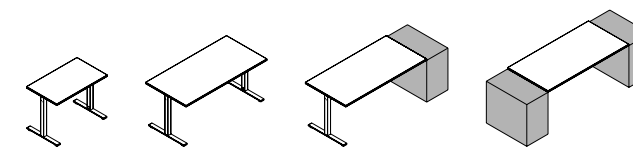

L = 800 / 1000 / 1200 / 1400 / 1600 / 1800 mm
P = 600 / 800 mm
H = 740 mm

CONTENITORI COMPLANARI / COPLANAR CABINETS

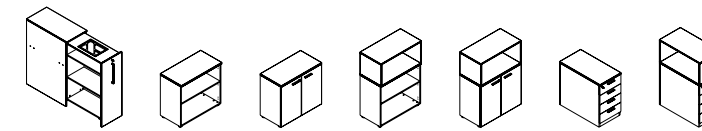

L = 800 mm
P = 400 mm
H = 740 / 1115 / 1315 mm

ALLUNGHI LATERALI / SIDE EXTENSION

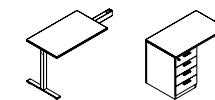

L = 800 / 1000 mm
P = 600 mm
H = 740 mm

ACCESSORI / ACCESSORIES

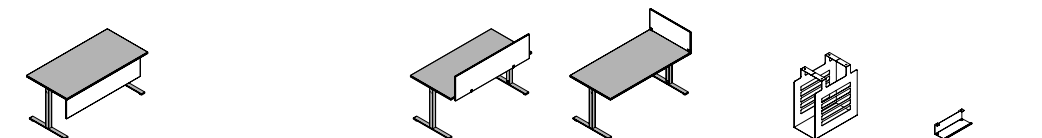

L = 1060 / 1260 / 1460 / 1660 mm
P = 18 mm
H = 375 mm

L = 800 / 1060 / 1260 / 1460 / 1660 mm
P = 18 / 28 mm
H = 465 (352) / 665 (552) mm

L = 250 mm
P = 500 mm
H = 560 mm

L = 320 mm
P = 120 mm
H = 100 mm

SLIM_OPERATIVE

Un sistema operativo modulare progettato per assicurare flessibilità, grazie ad una struttura metallica semplice ma altamente performante. Moltiplicare i posti di lavoro economizzando i costi per un'ottimizzazione degli spazi secondo i nuovi concetti del fare ufficio.

A modular operating system designed to assure flexibility, thanks to a metal structure simple but highly performed. Multiply the workstations, economizing costs, for space optimization according to the new concepts of doing office.





Vachetta reggicavi in metallo per scrivania singola.
Metal cable shelf for single desk.





Piano scrivania con top access in alluminio.
Desktop with top access in aluminium.



FINITURE / FINISHES

STRUTTURE IN METALLO / METAL STRUCTURE

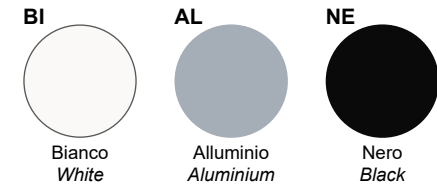

PIANI SCRIVANIA / DESKTOPS

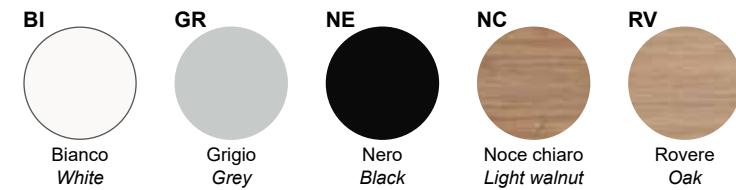

ACCESSORI IN MELAMINICO / MELAMINE ACCESSORIES

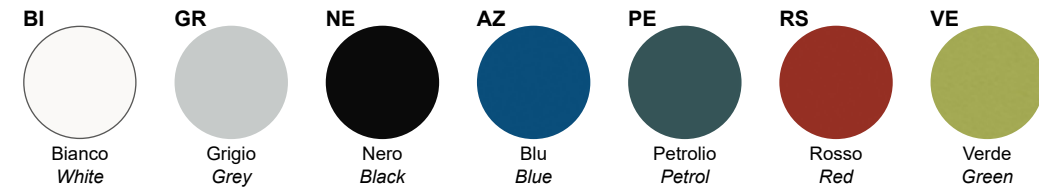

ACCESSORI IN TESSUTO / FABRIC ACCESSORIES

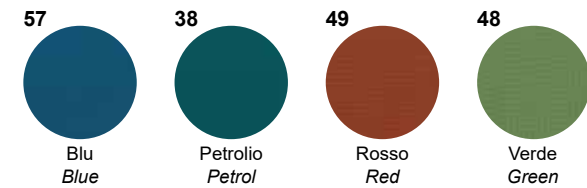

ABACO / ABACUS

SCRIVANIE / DESKS

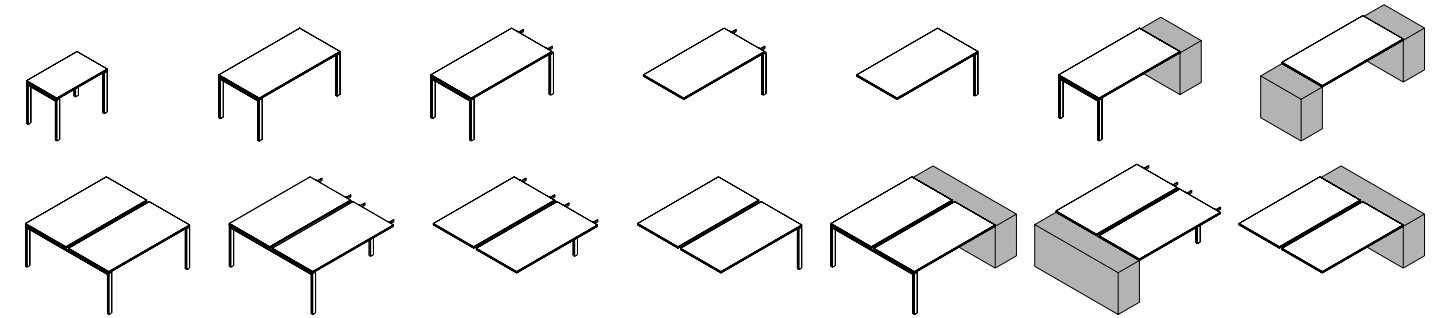

L = 800 / 1000 / 1200 / 1400 / 1600 / 1800 mm
P = 600 / 700 / 800 / 1450 / 1650 mm
H = 740 mm

CONTENITORI COMPLANARI / COPLANAR CABINETS

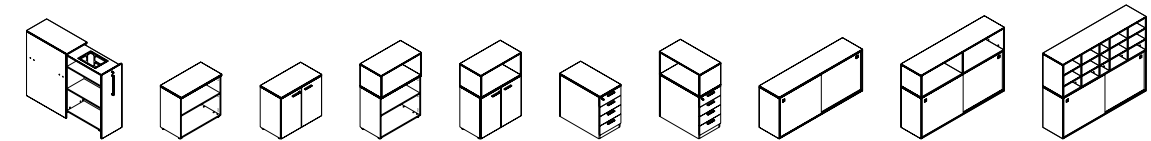

L = 800 / 1450 / 1650 mm
P = 400 mm
H = 740 / 1115 / 1315 mm

ALLUNGHI LATERALI / SIDE EXTENSIONS

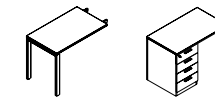

L = 800 / 1000 mm
P = 600 mm
H = 740 mm

ACCESSORI / ACCESSORIES

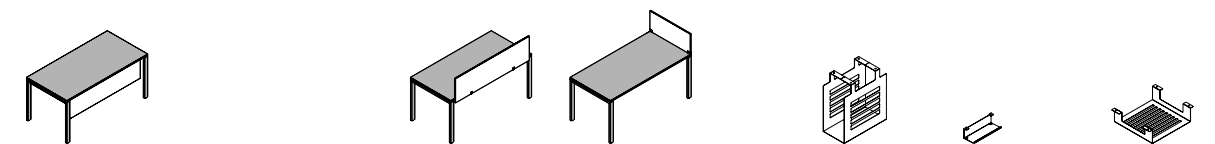

L = 1060 / 1260 / 1460 / 1660 mm
P = 18 mm
H = 375 mm

L = 700 / 800 / 1060 / 1260 / 1460 / 1660 mm
P = 18 / 28 mm
H = 465 (352) / 665 (552) mm

L = 250 mm
P = 500 mm
H = 560 mm

L = 320 mm
P = 120 mm
H = 100 mm

L = 450 mm
P = 520 mm
H = 140 mm

RING_OPERATIVE

Ring è stato progettato per massimizzare la flessibilità per una totale libertà di progettazione. La struttura metallica "ad anello", sottolinea l'essenzialità del suo design senza mancare di solida tecnologia.

Ring is designed to maximize flexibility for total freedom of layouts. The metal structure "ring" emphasizes the essentiality of its design without missing a solid technology.





Vaschetta reggicavi in metallo per scrivania condivisa.
Metal cable shelf for shared desk.





Pannello frontale in melaminico o tessuto in 2 altezze: 352 / 552 mm dal piano scrivania.

Melamine or fabric frontal screen in 2 heights: 352 / 552 mm from the desktop.



Scrivania con modesty panel.
Desk with modesty panel.



FINITURE / FINISHES

STRUTTURE IN METALLO / METAL STRUCTURE

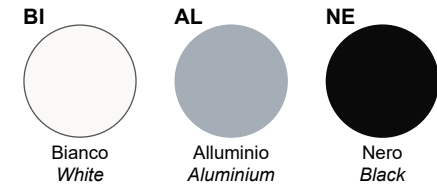

PIANI SCRIVANIA / DESKTOPS

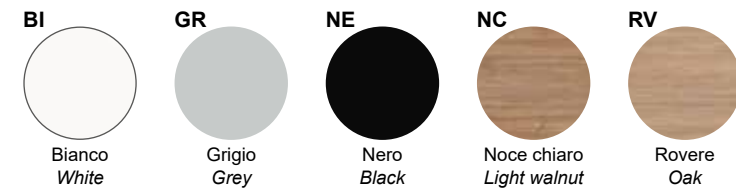

ACCESSORI IN MELAMINICO / MELAMINE ACCESSORIES

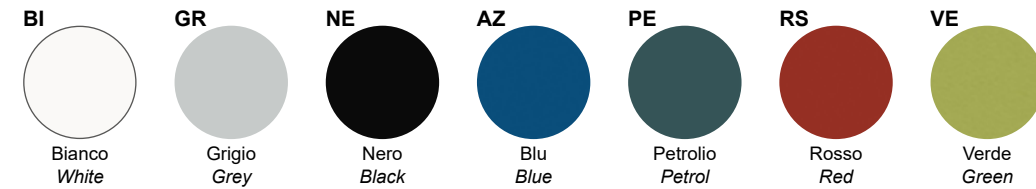

ACCESSORI IN TESSUTO / FABRIC ACCESSORIES

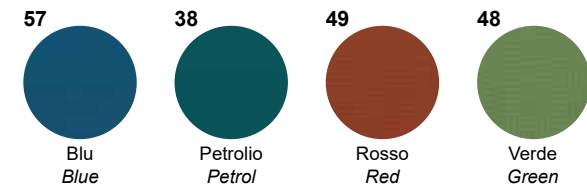

ABACO / ABACUS

SCRIVANIE / DESKS

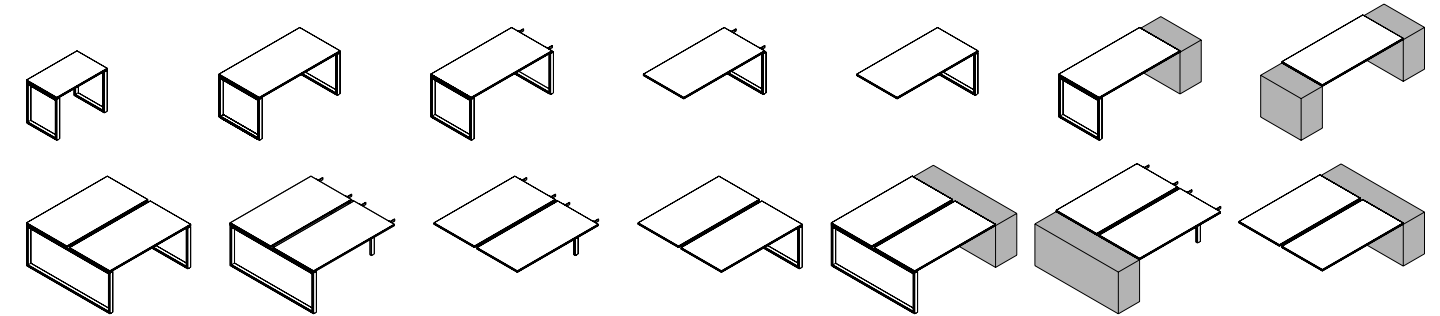

L = 800 / 1000 / 1200 / 1400 / 1600 / 1800 mm
P = 600 / 800 / 1650 mm
H = 740 mm

CONTENITORI COMPLANARI / COPLANAR CABINETS

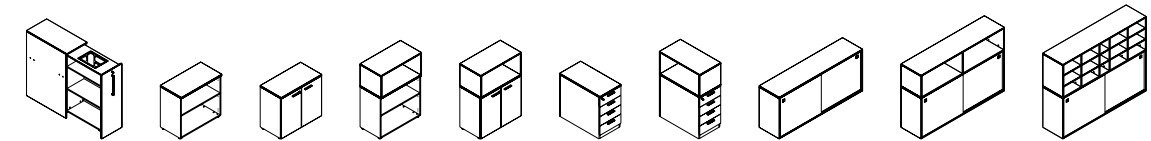

L = 800 / 1650 mm
P = 400 mm
H = 740 / 1115 / 1315 mm

ALLUNGHI LATERALI / SIDE EXTENSIONS

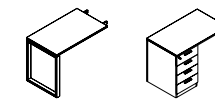

L = 800 / 1000 mm
P = 600 mm
H = 740 mm

ACCESSORI / ACCESSORIES

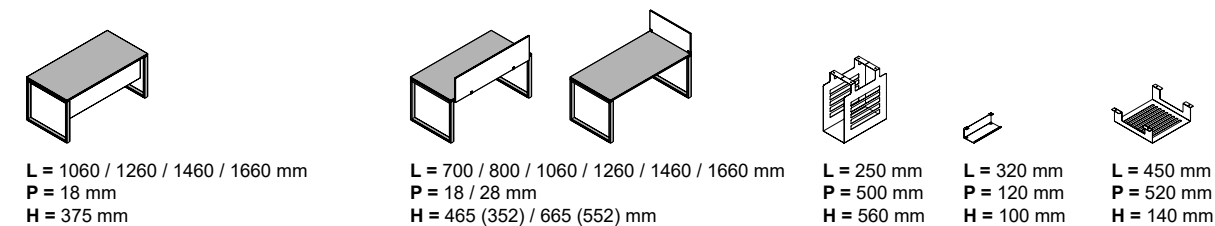

L = 1060 / 1260 / 1460 / 1660 mm
P = 18 mm
H = 375 mm

L = 700 / 800 / 1060 / 1260 / 1460 / 1660 mm
P = 18 / 28 mm
H = 465 (352) / 665 (552) mm

L = 250 mm
P = 500 mm
H = 560 mm

L = 320 mm
P = 120 mm
H = 100 mm

L = 450 mm
P = 520 mm
H = 140 mm

LIFT_OPERATIVE

Lift, una scrivania studiata per il benessere di chi lavora.

La regolazione in altezza del piano di lavoro contribuisce al miglioramento della postura e all'incremento della performance. È risaputo che le molte ore passate davanti alla scrivania non sono salutari. Lift permette di regolare elettricamente l'altezza ottimale del piano di lavoro e di operare stando in posizione eretta, alleggerendo così il carico sulla schiena.

Lift is a desk designed for the well-being of working people.

The height adjustment of the desktop contributes to improving posture and increasing performance. It is well known that the many hours spent in front of the desk are not healthy. Lift allows you to electrically adjust the optimal height of the desktop and to operate in an upright position, thus relieving the load on the back.



Struttura elevabile in altezza da 625mm
a 1275mm.

*Height adjustable structure from
625mm to 1275mm.*

Pannello frontale in melaminico o tessuto per scrivanie condivise.

Melamine or fabric frontal screen for shared desks.



FINITURE / FINISHES

STRUTTURE IN METALLO / METAL STRUCTURE

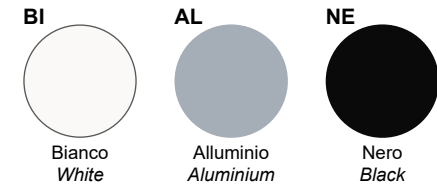

PIANI SCRIVANIA / DESKTOPS

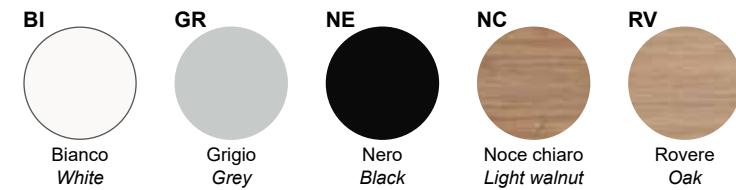

ACCESSORI IN MELAMINICO / MELAMINE ACCESSORIES

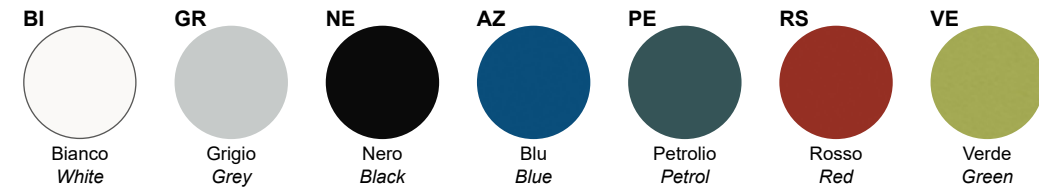

ACCESSORI IN TESSUTO / FABRIC ACCESSORIES

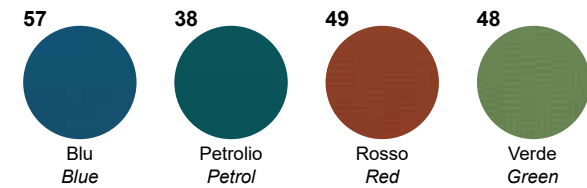

ABACO / ABACUS

SCRIVANIE / DESKS

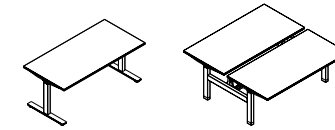

L = 1200 / 1400 / 1600 / 1800 mm
P = 800 / 1665 mm
H = 625 / 1275 mm

ACCESSORI / ACCESSORIES

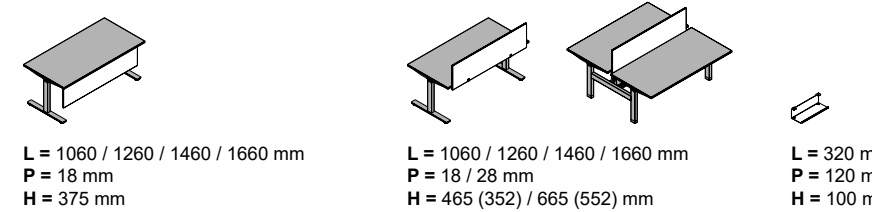

L = 1060 / 1260 / 1460 / 1660 mm
P = 18 mm
H = 375 mm

L = 1060 / 1260 / 1460 / 1660 mm
P = 18 / 28 mm
H = 465 (352) / 665 (552) mm

L = 320 mm
P = 120 mm
H = 100 mm

OASIS_OPERATIVE

Contenitori free-standing attrezzati ed accessoriati, concepiti per diventare isole di lavoro in grandi spazi comuni, dove isolarsi o interagire, individuando la postazione più consona alla necessità lavorativa del momento.

Freestanding cabinets, racks and shelves are fully equipped and accessorized, conceptualized to become work islands within large common areas, where one can be isolated or integrated, identifying the place that fits the most into the work needs of the moment.





Contenitore altezza 740 mm.
Cabinet height 740 mm.





Contenitore altezza 1300 mm.
Cabinet height 1300 mm.

Contenitore altezza 1700 mm.
Cabinet height 1700 mm.



FINITURE / FINISHES

STRUTTURE / CORPUS

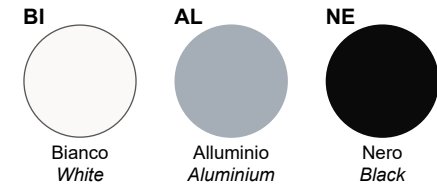

TOP / TOPS

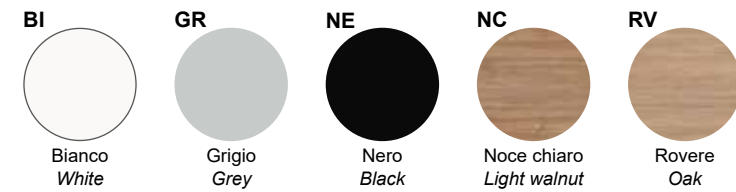

FRONTALI / FRONTALS

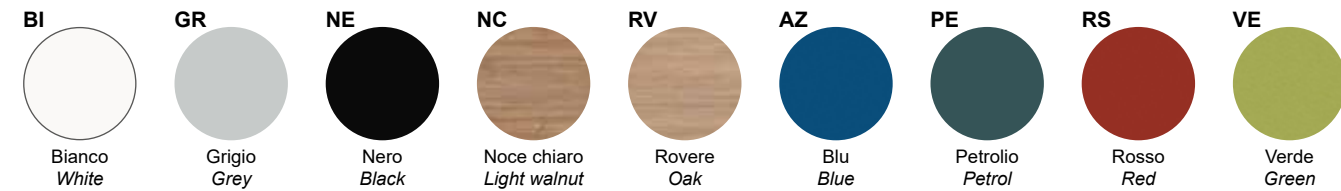

CUSCINI / CUCHIONS

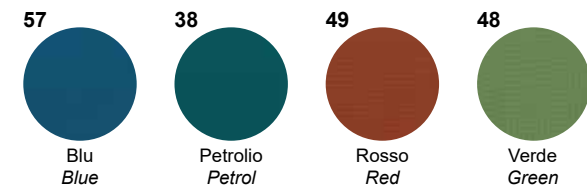

ABACO / ABACUS

CONTENITORI LATERALI / SIDE CABINETS

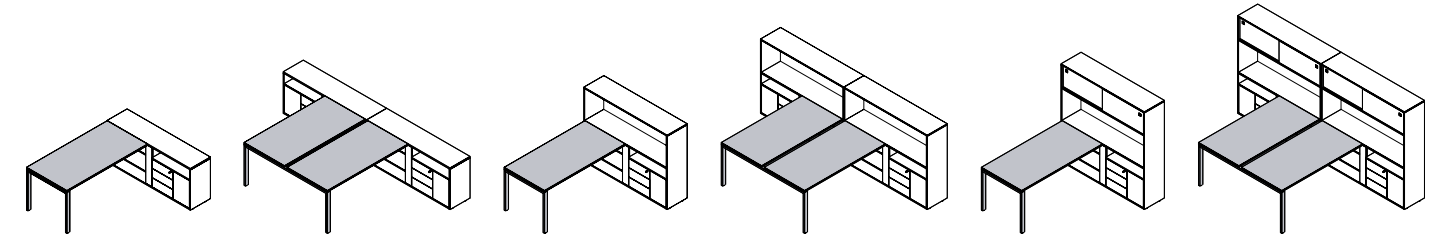

L = 1650 mm
P = 398 mm
H = 740 / 1300 / 1700 mm

CONTENITORI CONDIVISI / SHARED CABINETS

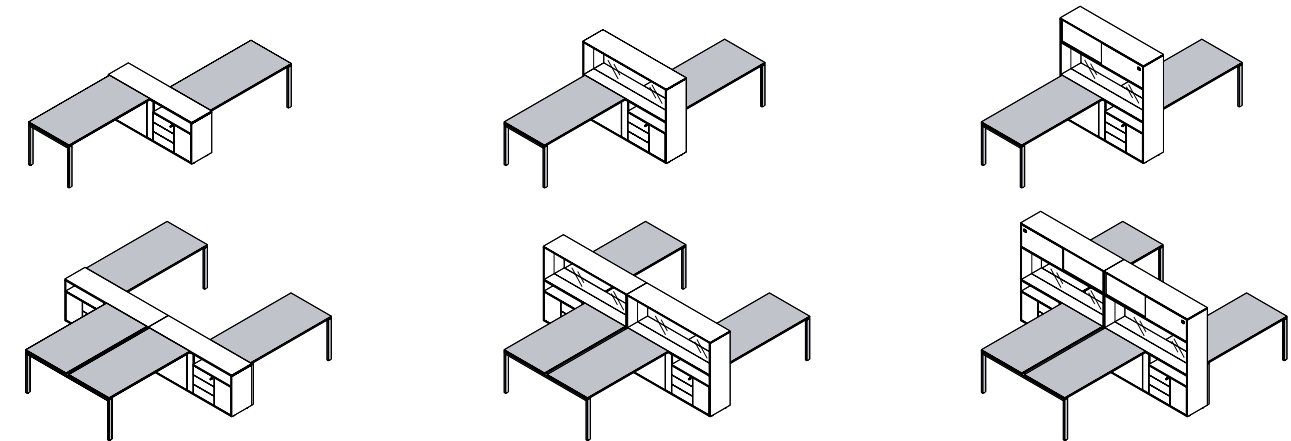

L = 1650 mm
P = 398 mm
H = 740 / 1300 / 1700 mm

CONTENITORI / CABINETS

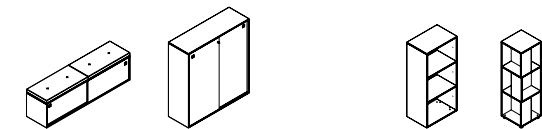

L = 1200 / 1650 mm
P = 398 mm
H = 500 / 1300 mm

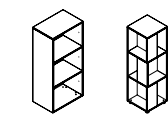

L = 398 / 600 mm
P = 398 mm
H = 1300 mm

BLOG_OPERATIVE

La modularità delle strutture offre la massima flessibilità e soluzioni illimitate per spazi riunione piccoli o grandi e omogeneità dell'ambiente di lavoro.

The modularity of the structures gives maximum flexibility and limitless solutions for small or large meeting spaces and homogeneity of the working environment.





Tavolino da caffè in 2 dimensioni: 600x600xH400mm e 1200x600xH400mm.

Coffee table in 2 dimensions: 600x600xH400mm and 1200x600xH400mm.





Top access in alluminio 334x156 mm
accessibile da entrambi i lati e completo
di vaschetta reggicavi.

*Aluminium top access 334x156 mm ac-
cessible from both sides and complete
of cable shelf.*



FINITURE / FINISHES

STRUTTURE IN METALLO / METAL STRUCTURE

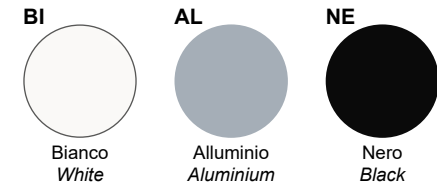

PIANI SCRIVANIA / DESKTOPS

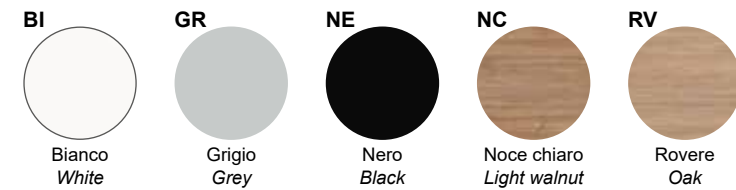

ACCESSORI IN MELAMINICO / MELAMINE ACCESSORIES

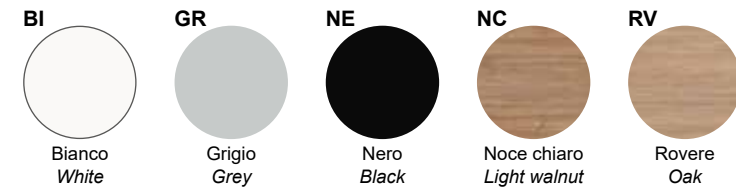

ABACO / ABACUS

COMPOSIZIONI ESEMPIO / EXAMPLES OF COMPOSITIONS

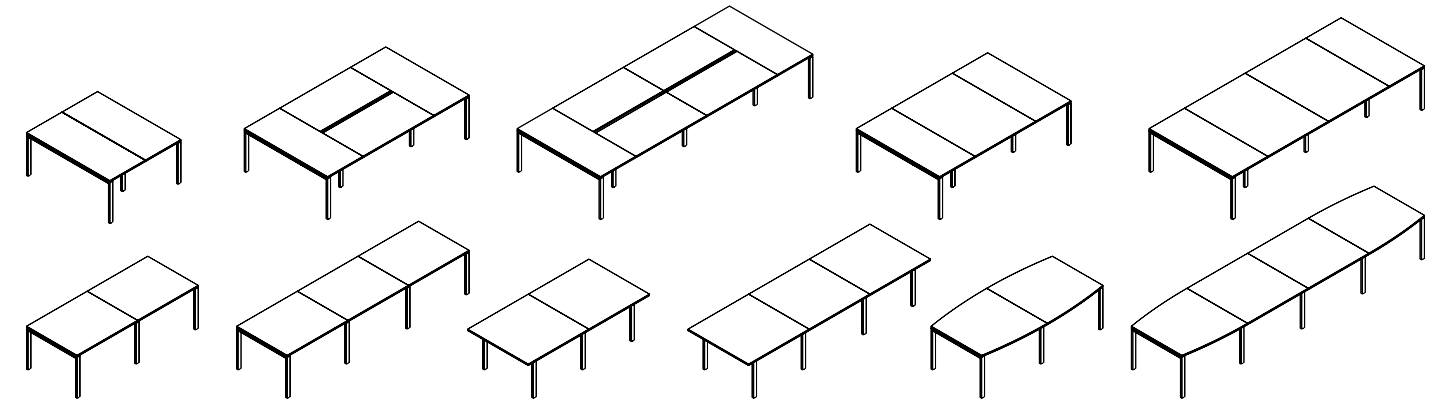

L = - mm
P = 1000 / 1200 / 1450 / 1650 mm
H = 740 mm

TAVOLI FOLDING / FOLDING TABLES



L = 1400 / 1600 / 1650 mm
P = 800 mm
H = 740 mm



L = 1260 / 1460 mm
P = 18 mm
H = 200 mm

TAVOLI RIUNIONE / MEETING TABLES



L = 800 / 1000 / 1200 mm
P = 800 / 1000 / 1200 mm
H = 740 mm

Ø = 800 / 1000 / 1200 mm
H = 740 mm

L = 1600 / 1800 mm
P = 700 mm
H = 1100 mm

TAVOLINI DA CAFFE' / COFFEE TABLES



L = 800 / 1200 mm
P = 600 / 800 mm
H = 400 / 475 mm



Ø = 600 mm
H = 475 mm

BOX_OPERATIVE

Un'organizzazione ottimale di lavoro.
Box offre contenitori e cassetti adattabili a tutte le linee.

An optimal organization of work. Box offers containers and drawers for storing adaptable to all lines.





Vaschetta porta cancelleria per casset-
tiera e mobile di servizio.

*Pencil tray for drawer unit and multipur-
pose cabinet.*





Mobile di servizio su ruote con 3 cassetti e anta.
Multipurpose cabinet on castors with 3 drawers and door.



FINITURE / FINISHES

STRUTTURE / CORPUS

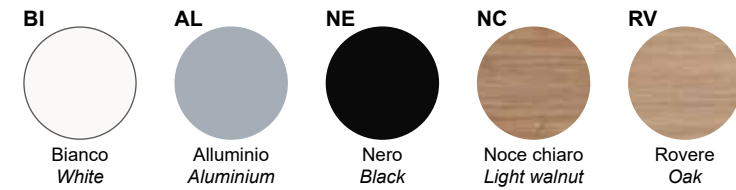

TOP / TOPS

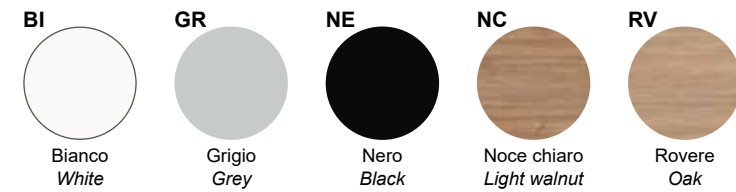

FRONTALI / FRONTALS

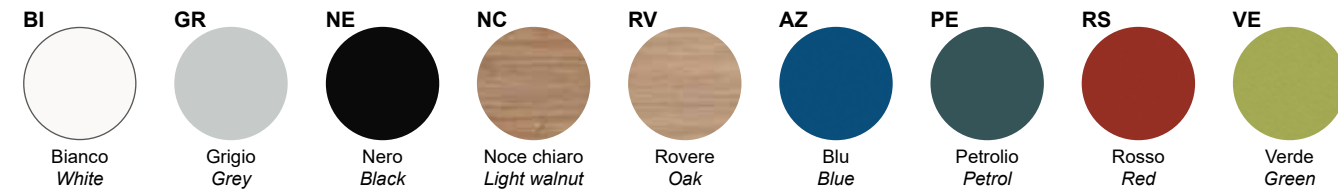

CUSCINI / CUSHIONS

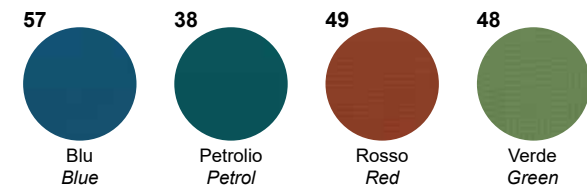

ABACO / ABACUS

CASSETTIERE E MOBILI DI SERVIZIO / DRAWER UNITS AND MULTIPURPOSE CABINETS

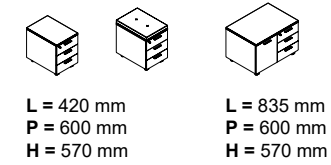

CONTENITORI / CABINETS

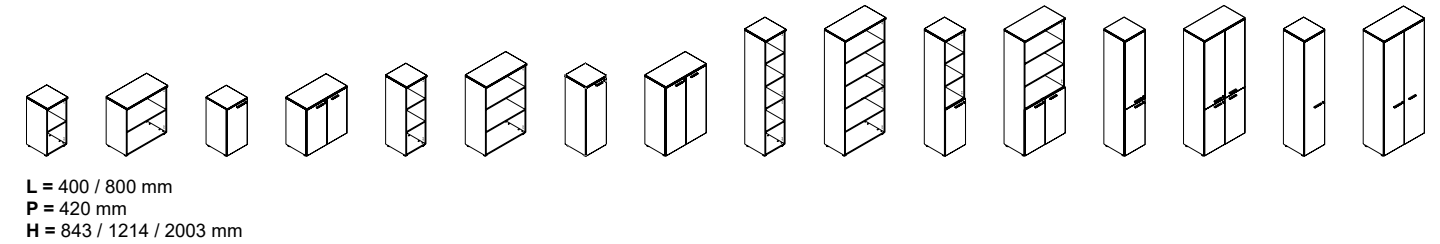

LOCKERS / LOCKERS

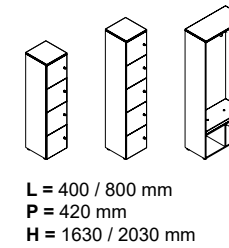

CONTENITORI ANTE SCORREVOLI / SLIDING DOORS CABINETS

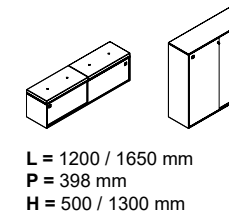

LOUNGE_OPERATIVE

Sistema di poltrone, divani, pouf e moduli componibili. Design italiano che abbina estetica e modernità ad un accurato standard qualitativo. Una collezione ideale per arredare con semplicità e funzionalità aree d'attesa, lounge e zone relax ed informali.

System of armchairs, sofas, poufs and aggregated modules. Italian design that combines aesthetics and modernity with an accurate quality standard. An ideal collection to furnish waiting and lounge rooms, relax and informal areas with simplicity and functionality.





Collezione poltroncina e pouf componibili tra di loro.
Modular armchair and pouf collection.





Poltroncina con struttura in legno.
Armchair with wooden structure.

Collezione poltrona e divani a 2 e 3 posti.

Collection of armchair and 2 and 3 seater sofas.



FINITURE / FINISHES

TESSUTO / FABRIC

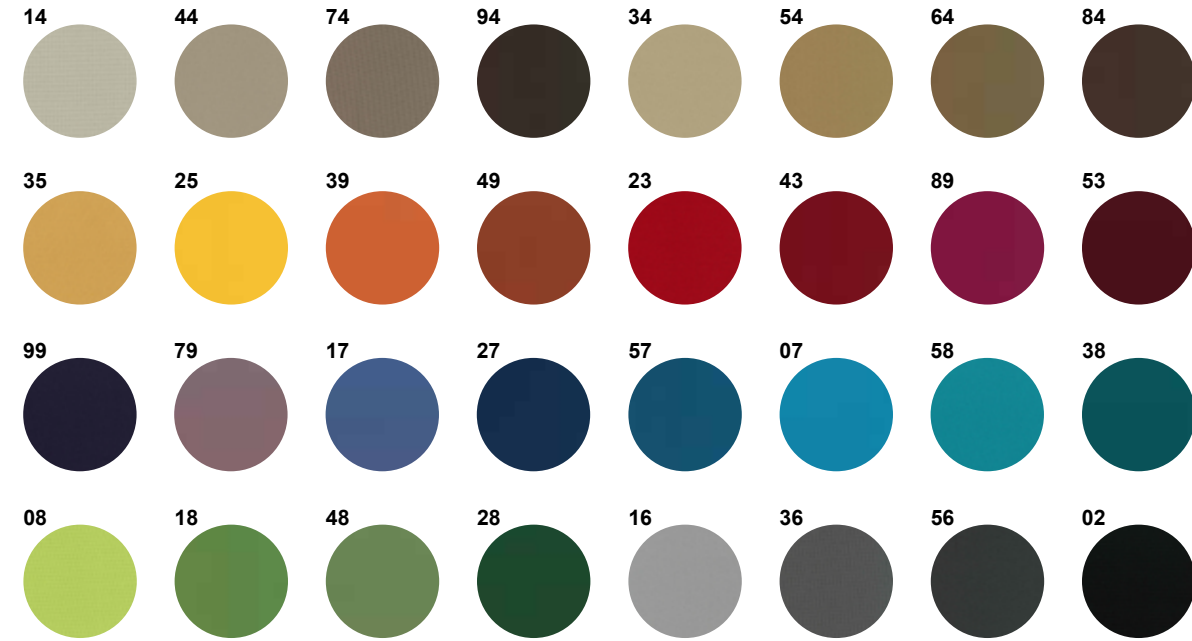

ABACO / ABACUS

POLTRONE E POUF / ARMCHAIRS AND POUF

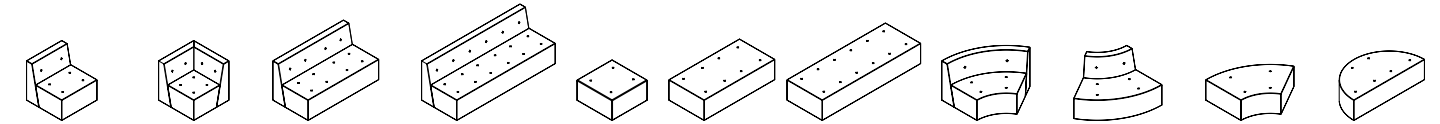

L = 700 / 1400 / 1950 mm
P = 700 mm
H = 375 / 700 mm

L = 1280 / 1400 mm
P = 700 mm
H = 375 / 700 mm

POLTRONE E POUF / ARMCHAIRS AND POUF



Ø = 600 mm
H = 375 / 700 mm



Ø = 600 mm
H = 385 / 680 mm

COMPOSIZIONI ESEMPIO / EXAMPLES OF COMPOSITIONS

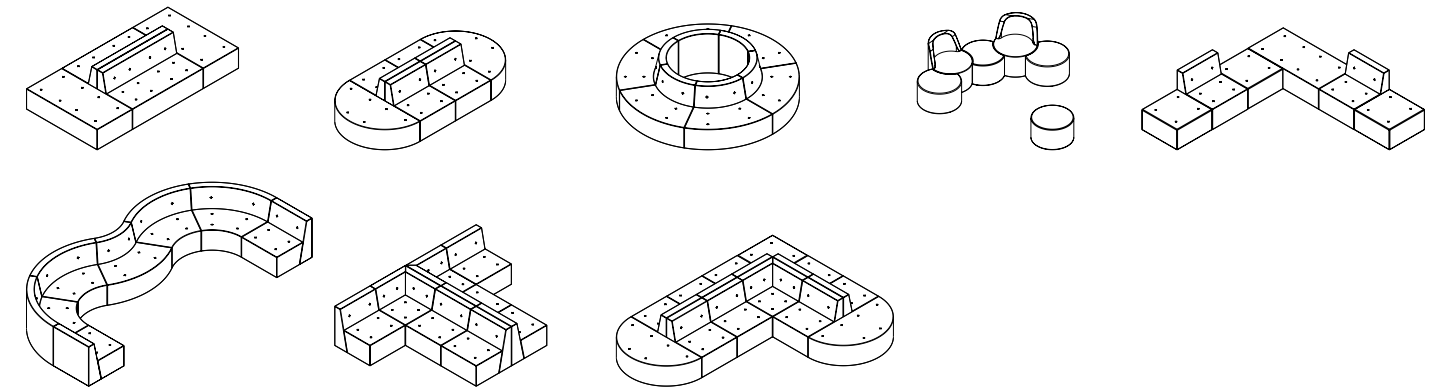

POLTRONE E DIVANI / ARMCHAIRS AND SOFAS

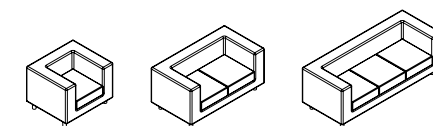

L = 850 / 1400 / 1900 mm
P = 800 mm
H = 650 mm

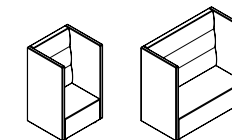

L = 800 / 1400 mm
P = 750 mm
H = 1300 mm

SLIM_MANAGERIAL

Tradizione e modernità, sobrietà estetica e accostamenti cromatici che contribuiscono a caratterizzare l'ambiente. L'intervento sul colore, portato su frontali di cassettiere e di contenitori, abbinato alle finiture legno, anima e personalizza gli scenari degli uffici.

Tradition and modernity, discreet aesthetics and colour combinations that contribute to distinguishing the environment. The colour used on the drawer and storage unit frontals combined with the wood finishes enlivens and customises the office settings.





Mobile di servizio completo di 3 casset-
ti, anta porta cpu e 2 ante.
*Multipurpose cabinet complete of 3
drawers, door for cpu and 2 doors.*

FINITURE / FINISHES

STRUTTURE IN METALLO / METAL STRUCTURE

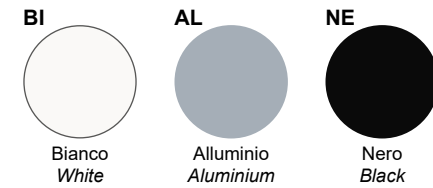

PIANI SCRIVANIA / DESKTOPS

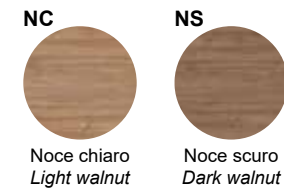

ACCESSORI IN MELAMINICO / MELAMINE ACCESSORIES



MOBILE DI SERVIZIO / MULTIPURPOSE CABINET



ABACO / ABACUS

SCRIVANIE / DESKS

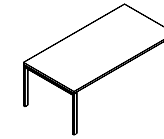

L = 1800 / 2000 mm
P = 1000 mm
H = 740 mm

ALLUNGHI LATERALI / SIDE EXTENSIONS



L = 800 / 1000 mm
P = 600 mm
H = 740 mm

SCRIVANIE / DESKS

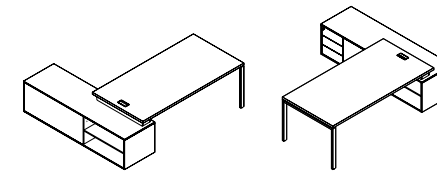

L = 2162 / 2362 mm
P = 2000 mm
H = 740 mm

ACCESSORI / ACCESSORIES

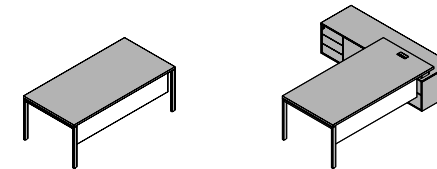

L = 1460 / 1660 / 1860 mm
P = 18 mm
H = 375 mm

RING_MANAGERIAL

Un arredamento sofisticato per rispondere ad un forte bisogno di immagine, caratterizzato dall'uso di finiture raffinate. Qualità e design della struttura, legni e metalli sono accostati con grande virtuosismo per un pubblico che sa distinguere ed apprezzare la raffinatezza.

Sophisticated furnishings to meet a strong need for image, characterized by the use of refined finishes. Wood and metal are combined with great virtuosity for a public that is able to distinguish and appreciate elegance.





Mobile di serizio completo di 3 cassetti,
anta porta cpu e 2 ante.
*Multipurpose cabinet complete of 3
drawers, door for cpu and 2 doors.*

FINITURE / FINISHES

STRUTTURE IN METALLO / METAL STRUCTURE

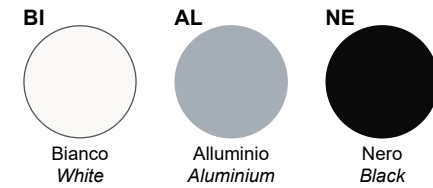

PIANI SCRIVANIA / DESKTOPS

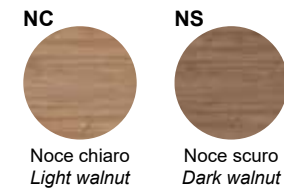

ACCESSORI IN MELAMINICO / MELAMINE ACCESSORIES



MOBILE DI SERVIZIO / MULTIPURPOSE CABINET



ABACO / ABACUS

SCRIVANIE / DESKS

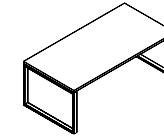

L = 1800 / 2000 mm
P = 1000 mm
H = 740 mm

ALLUNGHI LATERALI / SIDE EXTENSIONS



L = 800 / 1000 mm
P = 600 mm
H = 740 mm

SCRIVANIE / DESKS

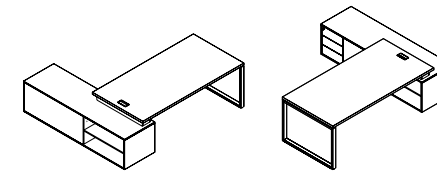

L = 2162 / 2362 mm
P = 2000 mm
H = 740 mm

ACCESSORI / ACCESSORIES

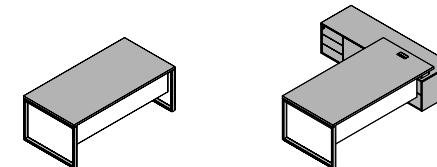

L = 1460 / 1660 / 1860 mm
P = 18 mm
H = 375 mm

OTTO_MANAGERIAL

Una linea direzionale il cui design, sobrio ed elegante, fonde modernità e tradizione: un prodotto senza tempo per uno stile unico. La scelta del colore delle finiture e degli spessori, conferisce prestigio ed una facile adattabilità.

A line whose directional design, sober and elegant, blends modernity and tradition: timeless furnishing concept for a unique style. The color choice of finishes and thicknesses confer prestige and easy adaptability.





Piano scrivania con top access in alluminio.
Desktop with top access in aluminium.

Piano scrivania con top access in alluminio.
Desktop with top access in aluminium.





FINITURE / FINISHES

GAMBE E PIANI / LEGS AND DESKTOPS

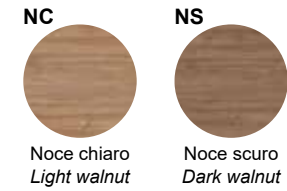

MODESTY PANEL / MODESTY PANEL



MOBILE DI SERVIZIO / MULTIPURPOSE CABINET

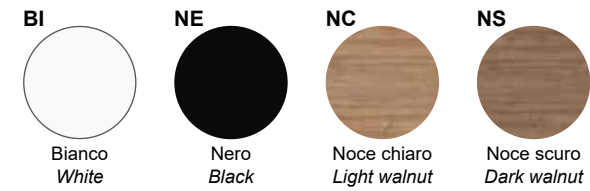

ABACO / ABACUS

SCRIVANIE / DESKS

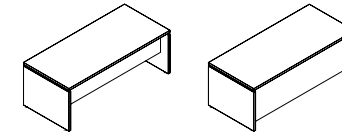

L = 1600 / 1800 / 2000 mm
P = 900 mm
H = 740 mm

ALLUNGO LATERALE / SIDE EXTENSION



L = 800 / 1000 mm
P = 600 mm
H = 740 mm

SCRIVANIE SU MOBILE DI SERVIZIO / DESKS ON MULTIPURPOSE CABINETS

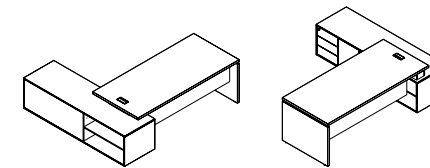

L = 2120 / 2320 mm
P = 2000 mm
H = 740 mm

GLAM_MANAGERIAL

Una linea direzionale caratterizzata da un design pulito ed elegante di grande impatto estetico e funzionale. Il modesty panel sagomato della scrivania è l'elemento distintivo che conferisce personalità e prestigio all'ambiente dell'ufficio.

An executive line characterized by a clean and elegant design of great aesthetic and functional impact. The shaped modesty panel of the desk is the distinctive element that gives personality and prestige to the office environment.





Mobile di serizio completo di 3 cassetti,
anta porta cpu e 2 ante.

*Multipurpose cabinet complete of 3
drawers, door for cpu and 2 doors.*





Tavolini da caffè in 2 dimensioni:
600x600xH400mm e 1200x600x-
H400mm.

*Coffee tables in 2 dimen-
sions: 600x600xH400mm and
1200x600x400mm.*

FINITURE / FINISHES

GAMBE E PIANI / LEGS AND DESKTOPS

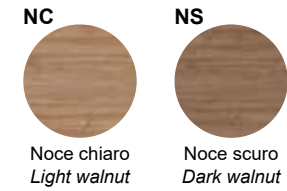

MODESTY PANEL - MURETTO / MODESTY PANEL - TYPEWALL



MOBILE DI SERVIZIO / MULTIPURPOSE CABINET



ABACO / ABACUS

SCRIVANIE / DESKS

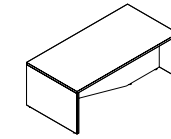

L = 1800 / 2000 mm
P = 1000 mm
H = 740 mm

ALLUNGO LATERALE / SIDE EXTENSION



L = 800 / 1000 mm
P = 600 mm
H = 740 mm

SCRIVANIE SU MOBILE DI SERVIZIO / DESKS ON MULTIPURPOSE CABINETS

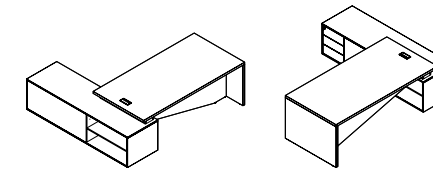

L = 2120 / 2320 mm
P = 2000 mm
H = 740 mm

SCRIVANIE CON MURETTO / DESKS WITH TYPEWALL

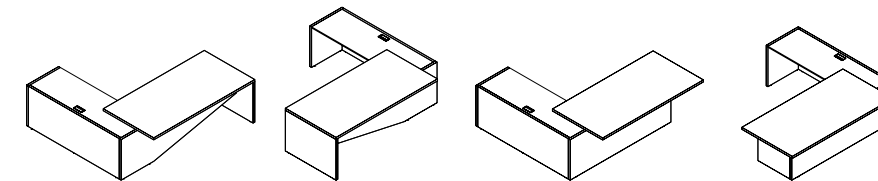

L = 2120 / 2320 mm
P = 2000 mm
H = 740 mm

La modularità delle strutture offre la massima flessibilità e soluzioni illimitate per spazi riunione piccoli o grandi e omogeneità dell'ambiente di lavoro.

The modularity of the structures gives maximum flexibility and limitless solutions for small or large meeting spaces and homogeneity of the working environment.





Tavolini da caffè in 2 dimensioni:
600x600xH400mm e 1200x600x-
H400mm.

*Coffee tables in 2 dimen-
sions: 600x600xH400mm and
1200x600x400mm.*

FINITURE / FINISHES

STRUTTURE IN METALLO / METAL STRUCTURE

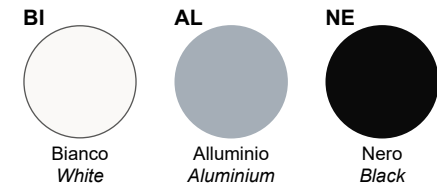

PIANI SCRIVANIA / DESKTOPS

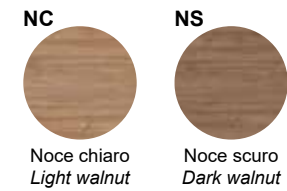

ABACO / ABACUS / ABAKUS

TAVOLI RIUNIONE / MEETING TABLES

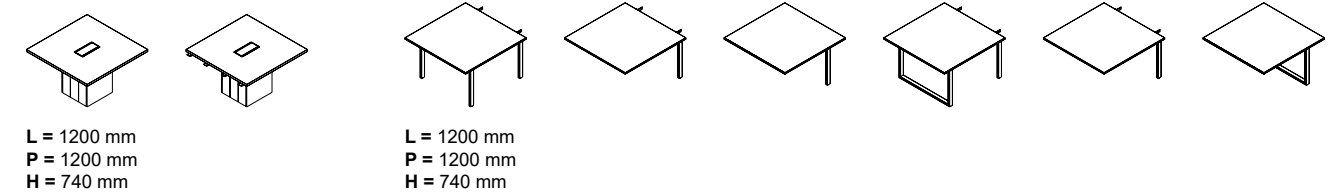

COMPOSIZIONI ESEMPIO / EXAMPLES OF COMPOSITIONS

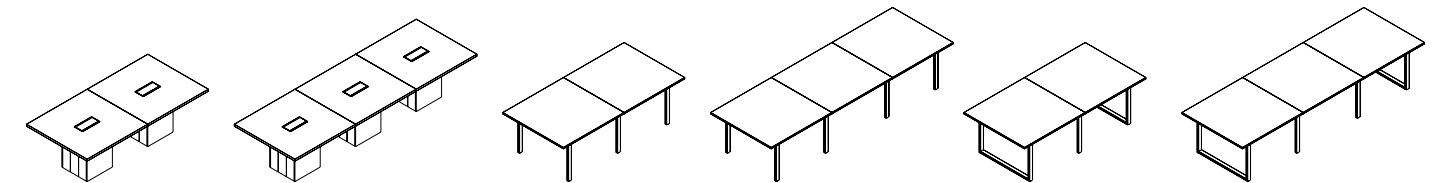

TAVOLI RIUNIONE / MEETING TABLES



TAVOLINI DA CAFFE' / COFFEE TABLES



BOX_MANAGERIAL

Un'organizzazione ottimale di lavoro.
Box offre contenitori e cassetti adattabili a tutte le linee.

An optimal organization of work. Box offers containers and drawers for storing adaptable to all lines.





Mobile di servizio su ruote con 3 cassette e anta.
Multipurpose cabinet on castors with 3 drawers and door.

FINITURE / FINISHES

STRUTTURE - TOP / CORPUS - TOPS

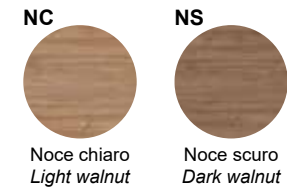

FRONTALI / FRONTALS



ABACO / ABACUS

CASSETTIERE E MOBILI DI SERVIZIO / DRAWER UNITS AND MULTIPURPOSE CABINETS

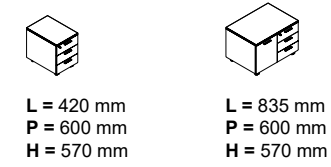

CONTENITORI / CABINETS

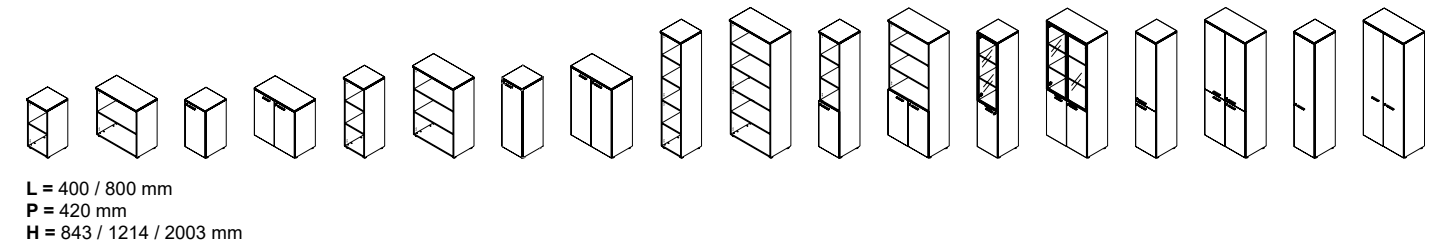

GUARDAROBA / WARDROBE

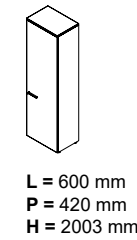

LIBRERIE / BOOKCASES

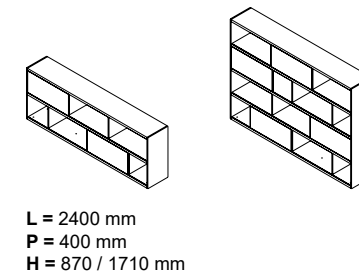

L'Azienda si riserva il diritto di apportare, senza preavviso, modifiche dimensionali, estetiche e tecniche ai prodotti.

The Company reserves the right to introduce changes to products sizes, aesthetical or technical aspects at any time without notice.

ANTARES
INTERNATIONAL

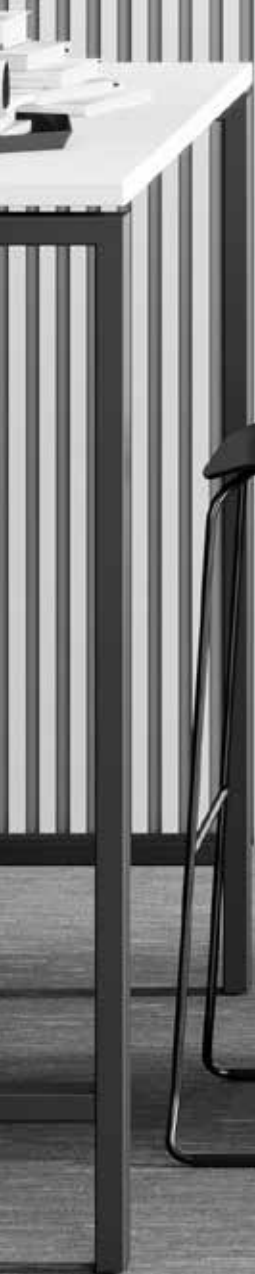

ANTARES BULGARIA LTD
www.antares-bg.net
antares@antares-bg.net